

VENTO EXPERT A50-1 W V.3

HEAT RECOVERY SINGLE-ROOM UNITS

Features

- Arrangement of efficient energy-saving, supply and exhaust, single-room ventilation in flats, houses, cottages, social and commercial premises.
- Reducing heat losses caused by ventilation due to heat recovery.
- Humidity balance and controllable air exchange create individually controlled micro-climate.
- Wi-Fi data exchange between several single-room ventilation units for coordinated operation.
- Controlled by Android or iOS smartphone or tablet.



Air flow:
up to 50 m³/h
14 l/s



Heat recovery efficiency:
up to 95 %



Power: from 5.0 W
SFP: from 1.22 W/l/s



Noise level:
from 4 dBA



Design

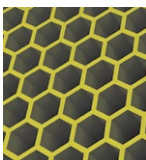
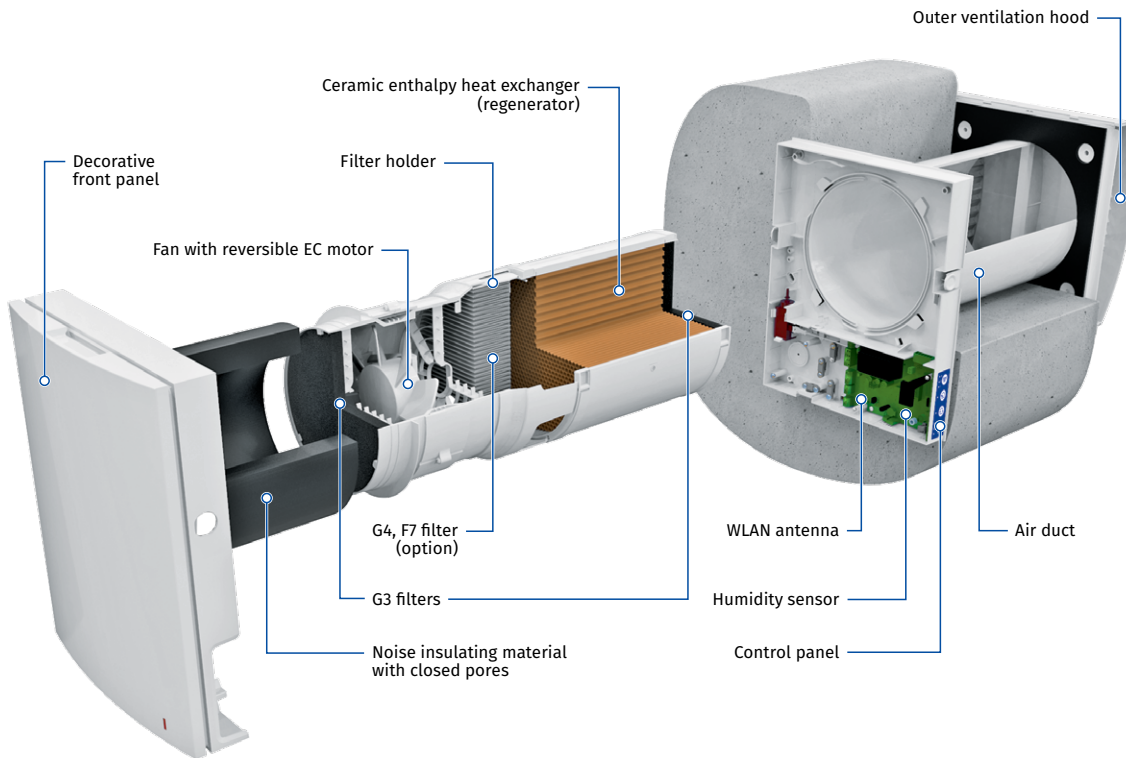

One of the best regeneration efficiency on the market due to innovative hexagonal structure of the heat exchanger cells



Built-in Wi-Fi for wireless communication between units and Android or iOS device control



Integrated automatic air shutters prevent air back drafting



The specially designed front panel can be closed manually to ensure 100 % air tightness and protect against wind impact



The demountable design of the regenerator cartridge improves heat recovery efficiency and simplifies maintenance

Designation key

Model	Air duct	Rated air flow [m ³ /h]	Front panel	Ventilation hood type	Control
Vento Expert	A: round air duct	50	-1: flat front panel	_ : white plastic hood AH-10 white 160 (for standard walls) S: metal hood (for thin walls)	W V.3: Control and setup of the unit with the Wi-Fi mobile application

VENTO EXPERT A50-1 W V.3

HEAT RECOVERY SINGLE-ROOM UNITS

Control

- Unit control via smartphone or tablet application.
- The units can be connected via Wi-Fi for synchronized operation.
- House ventilation control via cloud service from anywhere in the world.
- Connection to smart house or Building Management System (BMS) via Wi-Fi.

Blauberg Vento V.2 app for Android or iOS devices is available at Google Play and App Store.

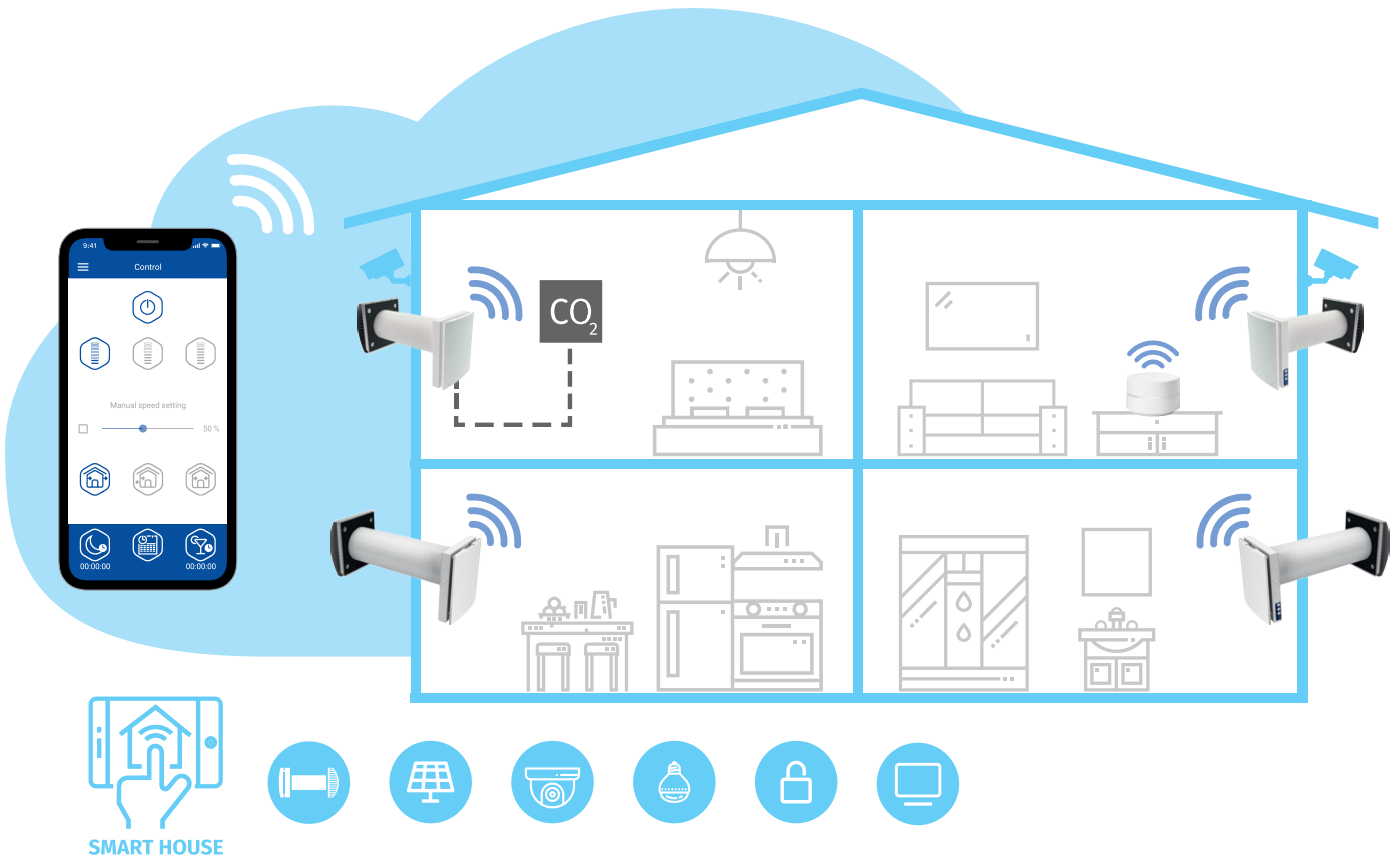

- Vento Expert A50-1 W V.3 either can operate as independent unit or can be connected with other units in a house and controlled with a master unit. In this case, only the master unit receives a signal from the remote control.

- Control of the unit operation mode is also performed by means of the sensor control panel located on the unit casing or the remote control.

FOR LIVING ROOMS AND BEDROOMS



FOR KITCHEN AND BATHROOM

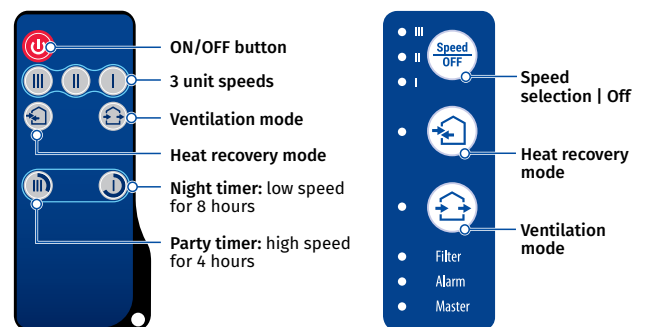

- Vento Expert is equipped with a humidity sensor for indoor humidity control. If humidity increases above a set point, the unit boosts to the speed III.

VENTO EXPERT A50-1 W V.3

HEAT RECOVERY SINGLE-ROOM UNITS

Energy recovery

UNIT OPERATING LOGIC IN WINTER PERIOD

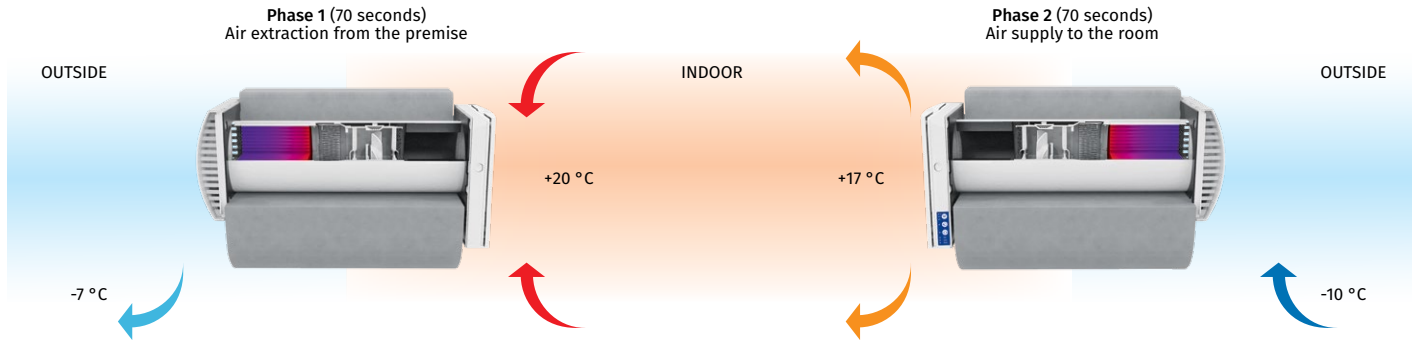

- Warm stale air is extracted from the premise, flows through the ceramic heat exchanger and transfers its heat and moisture to it.
- As the ceramic heat exchanger gets warmed up, the unit switches to the supply mode.
- Clean cold intake air flows through the heat exchanger and absorbs accumulated heat and humidity.
- When the heat exchanger is cooled down, the unit switches to the extract air mode.

Mounting

- The unit is designed for through-the-wall installation inside a prepared hole in an outer wall of the building.
- The best ventilation solution is pairwise installation of reverse phase synchronized units. Some units ensure supply of fresh air to the room and the other units extract air from the premise. This way the most efficient balanced ventilation is arranged.
- In case of brand new construction, units are mounted in two stages:
 - Pre-installation of an air duct and an outer ventilation hood at the stage of indoor finishing and outer decorative wall finishing.
 - Completion of the installation before commissioning of a house. It includes installation of the indoor unit with controller and shutters the cartridge, the heat exchanger, the fan and the filters.

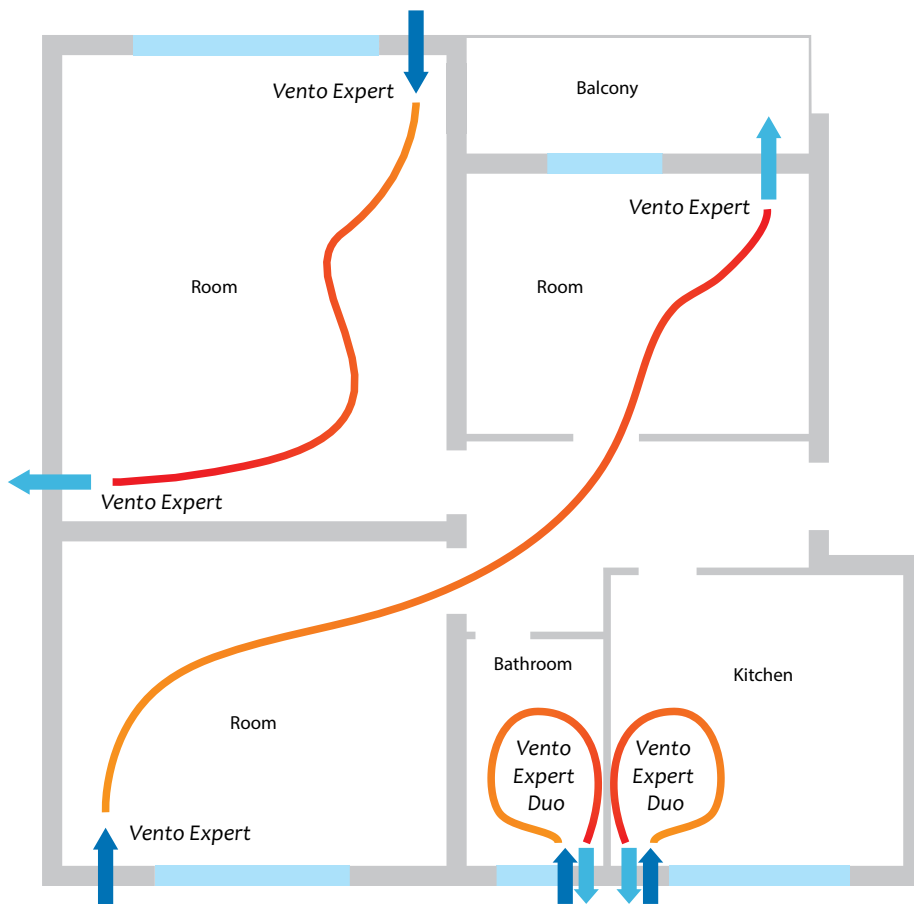

Angular mounting into a wall with standard thickness using
KIT BlauPlast white 160 / KIT BlauPlast chrome 160

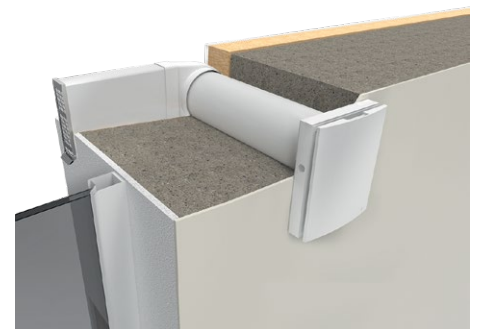

Unit installation example with the hood for thin walls
AH-S grey 160 / AH-S chrome 160

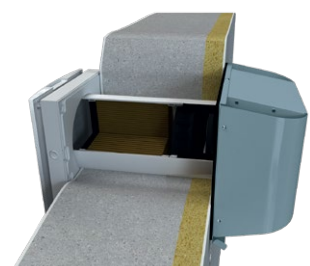

VENTO EXPERT A50-1 W V.3

HEAT RECOVERY SINGLE-ROOM UNITS

Technical data

Parameters	Vento Expert A50-1 W V.3 Vento Expert A50-1 S W V.3		
	I	II	III
Speed			
Voltage [V / 50 (60) Hz]		100-240	
Power [W]	5.0	6.0	8.5
Current [A]	0.035	0.040	0.059
RPM [min ⁻¹]	800	1300	1900
Air flow in ventilation mode [m ³ /h (l/s)]	15 (4)	30 (8)	50 (14)
Air flow in energy recovery mode [m ³ /h (l/s)]	8 (2)	15 (4)	25 (7)
SFP [W/l/s]	2.40	1.23	1.22
Filter	G3 (Option: G4; F7 PM2.5 > 70 %*)		
Transported air temperature [°C]	-20...+40		
Sound pressure level at 1 m in accordance with ISO 3741:2004 [dBA]	13	25	37
Sound pressure level at 3 m in accordance with ISO 3741:2004 [dBA]	4	16	28
Outdoor sound pressure attenuation in accordance with DIN EN 20140 [dBA]	41/47**		
Classification of air flow sensitivity to pressure difference variations in accordance with EN 13141-8	S3***		
Indoor/outdoor airtightness classification of the complete unit in accordance with EN 13141-8	D1		
Heat recovery efficiency in accordance with DIBt LÜ-A 20 [%]	up to 95		
Ingress protection rating	IP24		

* maximum air flow 40 m³/h
 ** with open and closed front panel
 *** manual setting of 100% speed in a mobile application

ENERG
 енергия · ενεργεια
 Y IA
 IE IA

BLAUBERG Vento Expert A50-1 W V.3

A+ A A- B C D E F G

A

47.4 dB

25 m³/h

ENERGIA · ЕНЕРГИЯ · ΕΝΕΡΓΕΙΑ · ENERGIA · ENERGY · ENERGIE · ENERGI
 2020 1254/2014

Overall dimensions [mm]

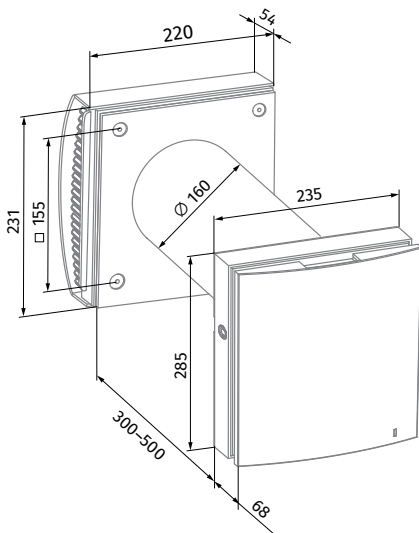

Vento Expert A50-1 W V.3

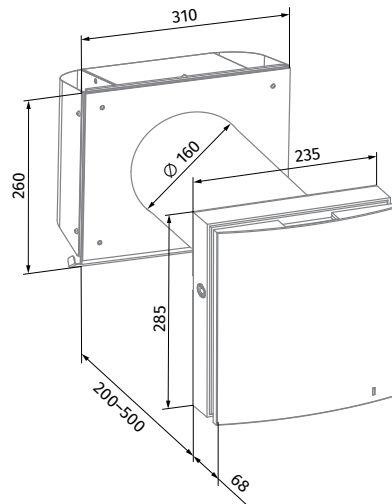













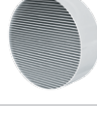

Vento Expert A50-1 S W V.3
 (for thin walls)

VENTO EXPERT A50-1 W V.3













HEAT RECOVERY SINGLE-ROOM UNITS

Accessories

Name		Description
Pre-installation Kit Vento Expert A50-1		Pre-installation kit for mounting into walls with standard thickness. Includes: • Air duct • AH-10 white 160 outer ventilation hood • Polystyrene foam plug • Polystyrene foam wedges
Pre-installation Kit Vento Expert A50-1 S		Pre-installation kit for mounting into thin walls. Includes: • Air duct • AH-S chrome 160 outer ventilation hood • Polystyrene foam plug • Polystyrene foam wedges
Completion Kit Vento Expert A50-1 W V.3		Final mounting kit. Includes: • Regenerator module • Fan module • G3 filters (2 pcs.) • Indoor unit with a controller and shutters • Remote control
FP2 Vento G3		G3 filters (2 pcs.)
FP2 Vento G4		Coarse filter. Includes: • Plastic filter holder (1 pc.) • G4 filter (1 pc.).
FPC 150x50 G4		G4 coarse filter
FP2 Vento F7		Filter set. Includes: • Plastic filter holder (1 pc.) • F7 fine filter (1 pc.). Filtration rate PM2.5 > 70 %
FPC 150x50 F7		F7 fine filter. Filtration rate PM2.5 > 70 %
AH-8 white 160		White painted aluminium outer ventilation hood with frost protection for a cold climate
AH-8 chrome 160		Brushed stainless steel outer ventilation hood with frost protection for a cold climate
AH-10 *colour* 160		Plastic outer ventilation hood. Available in colours: 
AH-10 chrome 160		Plastic outer ventilation hood with a plate with brushed stainless steel effect finish
AH-11 *colour* 160		Plastic outer ventilation hood. Available in colours: 

VENTO EXPERT A50-1 W V.3

HEAT RECOVERY SINGLE-ROOM UNITS

Name		Description
AH-S white 160		Stainless steel ventilation hood, painted white
AH-S chrome 160		Brushed stainless steel ventilation hood
PP 160/0.5		Outer ventilation hood for mounting from inside
KIT BlauPlast white 160		Kit for angular mounting with white colour grille (for walls with standard thickness)
KIT BlauPlast chrome 160		Kit for angular mounting with stainless steel outer grille (for walls with standard thickness)
R 160-500		500 mm air duct and polystyrene foam plug
R 160-700		700 mm air duct and polystyrene foam plug
SE Vento Expert W		Sensor control panel
FB Vento Expert A50		Remote control
CD-1		CO ₂ sensor with LED CO ₂ indication and a sensor button for operation mode selection
CD-2		CO ₂ sensor
S Vento Expert A50		Cardboard template for indoor installation of the unit